

MERLYN™

Vital Collection

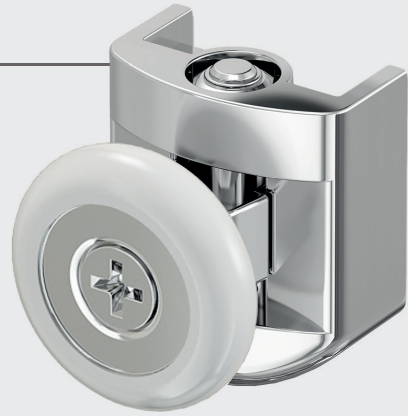

CLIP ON METAL ROLLERS



DESIGNED FOR YOUR **SPACE** AND YOUR **BUDGET**

MERLYN are passionate about design and craft, constantly innovating our range which comes with a built to last promise which has been created with you in mind.

MERLYN's quality design and innovative approach has lead to the creation of a range of shower enclosures to suit every budget and space, with an easy fit system that is a firm favourite with installers and tradespeople alike.

Crafted in the heart of Irish design!

SLOT & LOCK FRAME SYSTEM



Contents

about

Welcome to MERLYN	1
MERLYN Customer Service	2
MBOX	4
Sliding Door	5
Low Level Access Sliding Door	6
1 Door Quadrant	7
2 Door Quadrant	8
Pivot Door	9
Bifold Door	10
Corner Door	11
Easy	14
Corner Door	15
Sliding Door	16
2 Door Quadrant	17
Pivot Door	18
Bifold Door	19
8mm Wetroom Panels	22
Bathscreens	24
Touchstone Trays	26
Touchstone Slip Resistant Trays	28
<i>Product Information</i>	<i>30</i>
<i>MBOX Loft Heights</i>	<i>31</i>
<i>MBOX Extension Profiles</i>	<i>32</i>

MERLYN™

it's all about the experience

We've built our name and reputation on a simple ethos – to deliver on everything we promise to our customers.

This is because you are at the heart of everything we do. We have a relentless desire to deliver the highest level of attention to detail.

Our award-winning customer service department – and the wider MERLYN team live this ethos every single day.

We're passionate about innovation, quality and design, and this is reflected throughout our ranges. Our unique approach has resulted in us becoming the No.1 shower enclosure brand in the UK and Ireland. When you choose a MERLYN shower you are investing in one of the world's most luxurious showering environments and you get the added peace of mind of our Lifetime Guarantee.

Thank you for choosing MERLYN.

The MERLYN Team

Follow us online @merlynshowering to keep up to-date.      



Award-Winning Customer Service

It is not about what we do but what we can do for you. We promise we will always be there for you at any stage of your journey with MERLYN. We have a genuine commitment to service and to finding a solution for you. Our specialised team's philosophy is to make everything easy for you and we will respond immediately to any request you might have.

We strive everyday to make excellence a habit. Contact our award winning dedicated team of specialists, who are on hand to give you a personalised solution to your query.

Phone Number 056 779 1555 | WhatsApp 086 010 0002 | Online: irelandsales@merlyn.ie

Download our brochures.

Find your nearest stockist.

Download our easy-to-use fitting instructions and technical information.

Register your Guarantee.

Check out our website: www.merlynshowering.ie

NEW



INTRODUCING MBOX IN COLOUR
AVAILABLE TO ORDER FROM JUNE 2024

MBOX

SHOWER ENCLOSURES

Extensive Range - 53 sizes available

The MBOX range delivers stylish, quality products with additional Features and benefits including heights of 1800mm and 1900mm and comes with pre-assembled fixtures making it easier to fit.

MBOX offers loft height sizes (1800mm) in Sliding Doors, Bifold Doors, Two Door Quadrants and Side Panels. These loft sizes are ideal for low ceilings, making the most out of the space in your bathroom.

6^{MM}
GLASS
THICKNESS

10 YEARS
GUARANTEE

1900
MM
HEIGHT
STANDARD RANGE

Unique Easy Fit System



Double Rollers

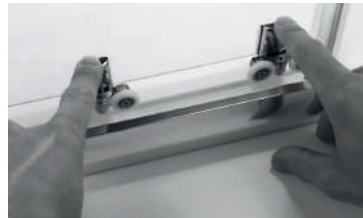

All rollers on MBOX products are double quick release for easy cleaning.

Inline Panels



MBOX offers Inline Panels that can be used in any space from 650mm to 1900mm.

Loft sizes



MBOX offers 3 reduced height doors. Perfect for converted loft spaces. Available in sliding door, bifold door, side panels and two door quadrant.

NEW



Sliding Door

Features

- » Height 1900mm
- » 6mm toughened safety glass
- » 10 year guarantee
- » Reversible
- » Magnetic seals
- » Easy to install
- » Mershield™ protected glass
- » Chrome designer handle
- » UKCA & CE Approved
- » 20mm adjustment per wall profile
- » Optional cover strips available - see pg 31
- » Loft heights are available in chrome only. See pg 31

Sliding door with Side Panel / Shown Right Hand / Brushed Brass

Sliding Door in Recess & for use with Side Panel				Chrome Pricing		Colour Pricing	
Size	Code	Colour Code	Adjustment	Price € Exc. VAT	Price € Inc. VAT	Price € Exc. VAT	Price € Inc. VAT
1000	MBS1000	add MB or BBR	950 - 990	447.97	551.00	530.89	653.00
1100	MBS1100	add MB or BBR	1050 - 1090	447.97	551.00	539.02	663.00
1200	MBS1200	add MB or BBR	1150 - 1190	447.97	551.00	546.34	672.00
1300	MBS1300	Chrome only	1250 - 1290	554.47	682.00	633.33	779.00
1400	MBS1400	add MB or BBR	1350 - 1390	554.47	682.00	665.04	818.00
1500	MBS1500	add MB or BBR	1450 - 1490	597.56	735.00	696.75	857.00
1600	MBS1600	Chrome only	1550 - 1590	597.56	735.00	N/A	N/A
1700	MBS1700	Chrome only	1650 - 1690	618.70	761.00	N/A	N/A

Please Note: Cover strips do not come as standard and need to be ordered separately if required - see page 31

Optional Side Panel				Chrome Pricing		Colour Pricing	
Size	Code	Colour Code	Adjustment	Price € Exc. VAT	Price € Inc. VAT	Price € Exc. VAT	Price € Inc. VAT
700	MBSP700	add MB or BBR	670 - 690	276.42	340.00	308.94	380.00
760	MBSP760	add MB or BBR	730 - 750	276.42	340.00	317.07	390.00
800	MBSP800	add MB or BBR	770 - 790	276.42	340.00	325.20	400.00
900	MBSP900	add MB or BBR	870 - 890	286.99	353.00	332.52	409.00
1000	MBSP1000	add MB or BBR	970 - 990	319.51	393.00	412.20	507.00

Optional Inline Panel - Chrome only				
Size	Code	Adjustment	Price € Exc. VAT	Price € Inc. VAT
150	MBN150	130 - 150	175.61	216.00
210	MBN210	190 - 210	175.61	216.00

For more information on Inline Panels see page 13

Colour Finishes; Express Yourself

When ordering your door please use the correct code to the size required. Then add the colour code you need. Example: MBS1000 is the standard chrome code add **MB** for Matt Black or **BBR** for Brushed Brass. **Example:** MBS1000 + MB (Matt Black) = MBS1000MB.

Chrome option is your standard code.



Technical drawing

Size	X	B
1000	367	430
1100	417	480
1200	467	530
1300	517	580
1400	567	630
1500	567	730
1600	567	830
1700	567	930

Sliding Door in Recess



Sliding Door with Side Panel



X: Door Opening
B = Fixed Panel
D = Side Panel



Low Level Access Sliding Door Chrome Only

Features

- » Height 1900mm
 - » 6mm toughened safety glass
 - » 10 year guarantee
 - » No bottom rollers
 - » Bottom glide system
 - » Easy-fit system
 - » Mershield™ protected glass
 - » Handed
 - » UKCA & CE Approved
 - » Push button door release for easy clean
 - » Adjustable fin seal for increased water retention
 - » Optional cover strips available - see pg 31
 - » Threshold strip just 6mm high
- Note: Products are left or right handed due to bottom guide and no bottom profile.

Low Level Access Sliding door with Side Panel / Shown Right Hand

Low Level Access Sliding Door

Size	Code	Adjustment	Price € Exc. VAT	Price € Inc. VAT
1000	MBLA1000L	950 - 990	521.14	641.00
1000	MBLA1000R	950 - 990	521.14	641.00
1200	MBLA1200L	1150 - 1190	521.14	641.00
1200	MBLA1200R	1150 - 1190	521.14	641.00
1400	MBLA1400L	1350 - 1390	646.34	795.00
1400	MBLA1400R	1350 - 1390	646.34	795.00
1700	MBLA1700L	1650 - 1690	721.14	887.00
1700	MBLA1700R	1650 - 1690	721.14	887.00

Please Note: Cover strips do not come as standard and need to be ordered separately if required - see page 31

Optional Side Panel

Size	Code	Adjustment	Price € Exc. VAT	Price € Inc. VAT
700	MBSP700	670 - 690	276.42	340.00
760	MBSP760	730 - 750	276.42	340.00
800	MBSP800	770 - 790	276.42	340.00
900	MBSP900	870 - 890	286.99	353.00
1000	MBSP1000	970 - 990	319.51	393.00



Low Level Access Sliding door in recess



Push Release

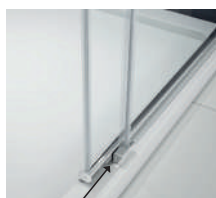

Bottom Glide System

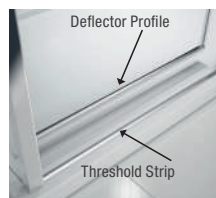

Slimline Threshold

Technical drawing

Size	X	B
1000	365	435
1200	465	535
1400	565	635
1700	565	935

Sliding Door with Side Panel

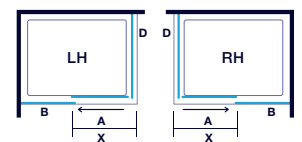

X: Door Opening
B = Fixed Panel
D = Side Panel



1 Door Quadrant

Features

- » Height 1900mm
- » 6mm toughened safety glass
- » 10 year guarantee
- » Reversible
- » Easy to install
- » Quick release double rollers for easy clean
- » Mershield™ protected glass
- » Chrome designer handle
- » UKCA & CE Approved
- » 20mm adjustment per wall profile
- » Optional cover strips available - see pg 31



1 Door Quadrant / Shown Right Hand / Brushed Brass

1 Door Quadrant				Chrome Pricing		Colour Pricing	
Size	Code	Colour Code	Adjustment	Price € Exc. VAT	Price € Inc. VAT	Price € Exc. VAT	Price € Inc. VAT
800 x 800	MB1Q800	add MB or BBR	770 - 790	533.33	656.00	665.04	818.00
900 x 900	MB1Q900	add MB or BBR	870 - 890	533.33	656.00	673.17	828.00
1000 x 1000	MB1Q1000	Chrome only	970 - 990	576.42	709.00	N/A	N/A

1 Door Offset Quadrant				Price € Exc. VAT	Price € Inc. VAT	Price € Exc. VAT	Price € Inc. VAT
900 x 760	MB1Q976	Chrome only	870 - 890 / 730 - 750	635.77	782.00	N/A	N/A
1000 x 800	MB1Q1080	add MB or BBR	970 - 990 / 770 - 790	640.65	788.00	791.87	974.00
1200 x 800	MB1Q1280	add MB or BBR	1170 - 1190 / 770 - 790	661.79	814.00	871.54	1072.00
1200 x 900	MB1Q1290	add MB or BBR	1170 - 1190 / 870 - 890	682.93	840.00	910.57	1120.00

Please Note: Cover strips do not come as standard and need to be ordered separately if required - see page 31



1 Door Offset Quadrant / Shown Left Hand

Colour Finishes; Express Yourself

When ordering your door please use the correct code to the size required. Then add the colour code you need. Example: MB1Q800 is the standard chrome code add **MB** for Matt Black or **BBR** for Brushed Brass. **Example:** MB1Q800 + MB (Matt Black) = MB1Q800MB.

Chrome option is your standard code.



Technical drawing

Size	X	B	C
800 x 800	422	490	235
900 x 760	310	448	550
900 x 900	476	529	335
1000 x 800	422	490	435
1000 x 1000	476	629	435
1200 x 800	424	490	635
1200 x 900	475	529	635

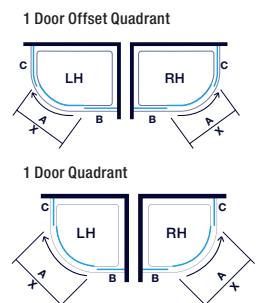

B: Straight Panel
C: Curved Panel
X: Door Opening



2 Door Quadrant / Matt Black

2 Door Quadrant

Features

- » Height 1900mm
- » 6mm toughened safety glass
- » 10 year guarantee
- » Reversible
- » Magnetic seals
- » Easy to install
- » Quick release double rollers for easy clean
- » Mershield™ protected glass
- » Chrome designer handle
- » UKCA & CE Approved
- » 20mm adjustment per wall profile
- » Optional cover strips available - see pg 31
- » Loft heights are available in chrome only. See pg 31



2 Door Quadrant				Chrome Pricing		Colour Pricing	
Size	Code	Colour Code	Adjustment	Price € Exc. VAT	Price € Inc. VAT	Price € Exc. VAT	Price € Inc. VAT
800 x 800	MB2Q800	add MB or BBR	770 - 790	443.09	545.00	554.47	682.00
900 x 900	MB2Q900	add MB or BBR	870 - 890	447.97	551.00	562.60	692.00

2 Door Offset Quadrant				Chrome Pricing		Colour Pricing	
Size	Code	Colour Code	Adjustment	Price € Exc. VAT	Price € Inc. VAT	Price € Exc. VAT	Price € Inc. VAT
900 x 760	MB2Q9076	Chrome only	870 - 890 / 730 - 750	533.33	656.00	N/A	N/A
900 x 800	MB2Q8090	Chrome only	870 - 890 / 770 - 790	533.33	656.00	N/A	N/A
1000 x 800	MB2Q1080	Chrome only	970 - 990 / 770 - 790	554.47	682.00	N/A	N/A
1200 x 800	MB2Q1280	Chrome only	1170 - 1190 / 770 - 790	576.42	709.00	N/A	N/A
1200 x 900	MB2Q1290	Chrome only	1170 - 1190 / 870 - 890	618.70	761.00	N/A	N/A

Please Note: Cover strips do not come as standard and need to be ordered separately if required - see page 31



2 Door Offset Quadrant

Colour Finishes; Express Yourself

When ordering your door please use the correct code to the size required. Then add the colour code you need. Example: MB2Q800 is the standard chrome code add **MB** for Matt Black or **BBR** for Brushed Brass. **Example:** MB2Q800 + MB (Matt Black) = MB2Q800MB.

Chrome option is your standard code.



BBR = Brushed Brass Standard Chrome MB = Matt Black

Technical drawing

Size	X	B	C
800 x 800	410	235	235
900 x 760	432	335	195
900 x 900	524	335	335
900 x 800	473	335	235
1000 x 800	465	435	235
1200 x 800	465	635	235
1200 x 900	524	635	335

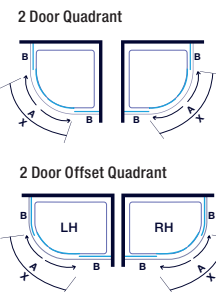

B: Straight Panel
C: Curved Panel
X: Door Opening

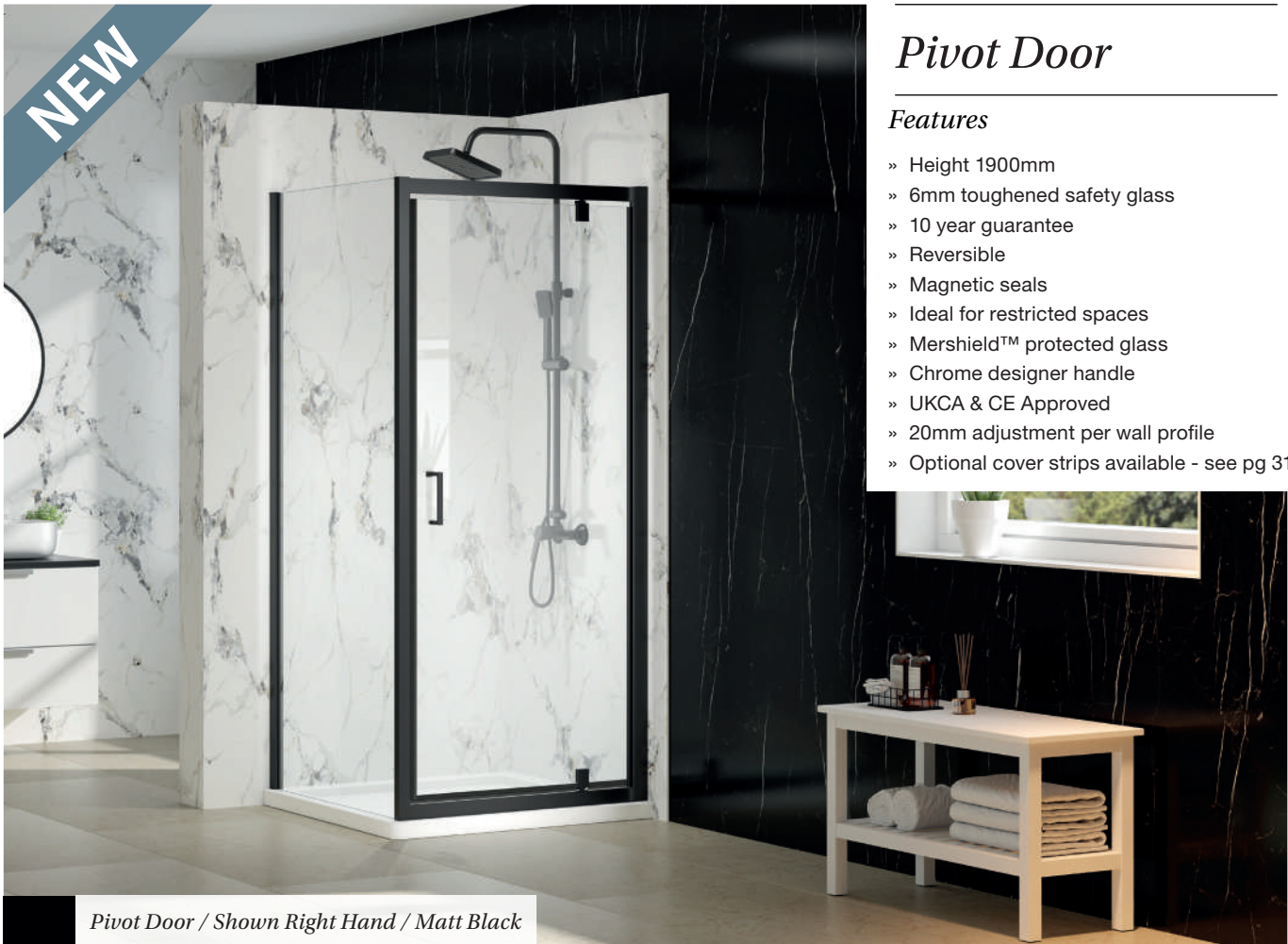

Pivot Door

Features

- » Height 1900mm
- » 6mm toughened safety glass
- » 10 year guarantee
- » Reversible
- » Magnetic seals
- » Ideal for restricted spaces
- » Mershield™ protected glass
- » Chrome designer handle
- » UKCA & CE Approved
- » 20mm adjustment per wall profile
- » Optional cover strips available - see pg 31

Pivot Door / Shown Right Hand / Matt Black

Pivot Door		Chrome Pricing			Colour Pricing		
Size	Code	Colour Code	Adjustment	Price € Exc. VAT	Price € Inc. VAT	Price € Exc. VAT	Price € Inc. VAT
700	MBP700	Chrome only	650 - 690	424.39	522.00	N/A	N/A
760	MBP760	add MB or BBR	710 - 750	426.02	524.00	459.35	565.00
800	MBP800	add MB or BBR	750 - 790	426.02	524.00	467.48	575.00
900	MBP900	add MB or BBR	850 - 890	447.97	551.00	482.93	594.00
1000	MBP1000	Chrome only	950 - 990	469.11	577.00	N/A	N/A

Please Note: Cover strips do not come as standard and need to be ordered separately if required - see page 31

Optional Side Panel		Chrome Pricing			Colour Pricing		
Size	Code	Colour Code	Adjustment	Price € Exc. VAT	Price € Inc. VAT	Price € Exc. VAT	Price € Inc. VAT
700	MBSP700	add MB or BBR	670 - 690	276.42	340.00	308.94	380.00
760	MBSP760	add MB or BBR	730 - 750	276.42	340.00	317.07	390.00
800	MBSP800	add MB or BBR	770 - 790	276.42	340.00	325.20	400.00
900	MBSP900	add MB or BBR	870 - 890	286.99	353.00	332.52	409.00
1000	MBSP1000	add MB or BBR	970 - 990	319.51	393.00	412.20	507.00

Optional Inline Panel - Chrome only				
Size	Code	Adjustment	Price € Exc. VAT	Price € Inc. VAT
150	MBN150	130 - 150	175.61	216.00
210	MBN210	190 - 210	175.61	216.00

For more information on Inline Panels see page 13

Colour Finishes; Express Yourself

When ordering your door please use the correct code to the size required. Then add the colour code you need. Example: MBP700 is the standard chrome code add **MB** for Matt Black or **BBR** for Brushed Brass. **Example:** MBP700 + MB (Matt Black) = MBP700MB.

Chrome option is your standard code.



Technical drawing

Pivot Door in Recess

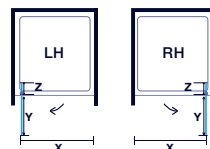

Pivot Door with Side Panel

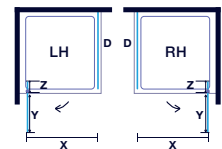

Size	X	Y
700	451	433
760	511	493
800	551	533
900	600	583
1000	671	653

D: Side Panel
Y: Outside Door Swing
X: Door Opening
Z: Inside Door Swing



NEW

Bifold Door

Features

- » Height 1900mm
- » 4mm toughened safety glass
- » 10 year guarantee
- » Reversible
- » Magnetic seals
- » Mershield™ protected glass
- » Chrome designer handle
- » UKCA & CE Approved
- » 20mm adjustment per wall profile
- » Optional cover strips available - see pg 31
- » Loft heights are available in chrome only. See pg 31

Bifold Door / Shown Right Hand / Brushed Brass

Bifold Door		Chrome Pricing			Colour Pricing		
Size	Code	Colour Code	Adjustment	Price € Exc. VAT	Price € Inc. VAT	Price € Exc. VAT	Price € Inc. VAT
700	MBB700	Chrome only	650 - 690	404.88	498.00	N/A	N/A
760	MBB760	add MB or BBR	710 - 750	426.02	524.00	507.32	624.00
800	MBB800	add MB or BBR	750 - 790	426.02	524.00	514.63	633.00
900	MBB900	add MB or BBR	850 - 890	447.97	551.00	522.76	643.00
1000	MBB1000	add MB or BBR	950 - 990	469.11	577.00	602.44	741.00

Please Note: Cover strips do not come as standard and need to be ordered separately if required - see page 31

Optional Side Panel		Chrome Pricing			Colour Pricing		
Size	Code	Colour Code	Adjustment	Price € Exc. VAT	Price € Inc. VAT	Price € Exc. VAT	Price € Inc. VAT
700	MBSP700	add MB or BBR	670 - 690	276.42	340.00	308.94	380.00
760	MBSP760	add MB or BBR	730 - 750	276.42	340.00	317.07	390.00
800	MBSP800	add MB or BBR	770 - 790	276.42	340.00	325.20	400.00
900	MBSP900	add MB or BBR	870 - 890	286.99	353.00	332.52	409.00
1000	MBSP1000	add MB or BBR	970 - 990	319.51	393.00	412.20	507.00

Optional Inline Panel - Chrome only

Size	Code	Adjustment	Price € Exc. VAT	Price € Inc. VAT
150	MBN150	130 - 150	175.61	216.00
210	MBN210	190 - 210	175.61	216.00

For more information on Inline Panels see page 12

Colour Finishes; Express Yourself

When ordering your door please use the correct code to the size required. Then add the colour code you need. Example: MBB700 is the standard chrome code add **MB** for Matt Black or **BBR** for Brushed Brass. **Example:** MBB700 + MB (Matt Black) = MBB700MB.

Chrome option is your standard code.



Technical drawing

Bifold Door in Recess

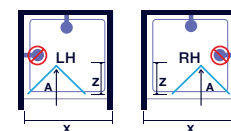

Bifold Door with Side Panel

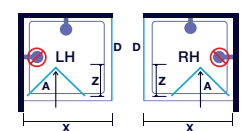

Size	X	Z
700	370	284
760	430	315
800	470	336
900	570	387
1000	670	438

A: Moving Panel
D: Side Panel
X: Door Opening
Z: Width of panel when folded

Corner Door Chrome Only

Features

- » Height 1900mm
- » 6mm toughened safety glass
- » 10 year guarantee
- » Reversible
- » Magnetic seals
- » Easy to install
- » Mershield™ protected glass
- » Chrome designer handle
- » UKCA & CE Approved
- » 20mm adjustment per wall profile
- » Optional cover strips available - see pg 31



Corner Door

Corner Door

Size	Code	Adjustment	Price € Exc. VAT	Price € Inc. VAT
760 x 760	MBC760	730 - 750	462.60	569.00
800 x 800	MBC800	770 - 790	462.60	569.00
900 x 900	MBC900	870 - 890	477.24	587.00

Please Note: Cover strips do not come as standard and need to be ordered separately if required - see page 31

Technical drawing

Size	X	B
760 x 760	345	310
800 x 800	375	330
900 x 900	444	380

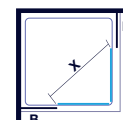

X: Door Opening
B: Fixed Panel

Inline Panels - Chrome Only

MBOX also offers you additional Inline Panel options. A great solution for spaces which don't suit standard size enclosures. The two Inline Panel sizes each combined with our existing Sliding, Bifold and Pivot Doors, can make an enclosure to fit any space from 650mm to 1900mm wide.

Size	Code	Price € Ex. VAT	Price € Inc. VAT
150	MBN150	175.61	216.00
210	MBN210	175.61	216.00



Sliding door with inline panel



Pivot door with inline panel



Bifold door with inline panel

Sliding Door - with inline panel

Code	Door Size	Door Adjustment	Inline Panels / Profile	Final Adjustment
MBS1000	1000	950-990	-	950-990
			EXT Profile	970-1010
MBS1000	1000	950-990	3 EXT Profile	990-1050
MBS1100	1100	1050-1090	-	1050-1090
			EXT Profile	1070-1110
MBS1000	1000	950-990	150 Inline	1080-1140
			210 Inline	1140-1200
MBS1100	1100	1050-1090	150 Inline	1180-1240
			210 Inline	1240-1300
MBS1200	1200	1150-1190	150 Inline	1280-1340
MBS1400	1400	1350-1390	-	1350-1390
			EXT Profile	1370-1410
MBS1100	1100	1050-1090	150+210 Inlines	1370-1450
MBS1500	1500	1450-1490	-	1450-1490
			EXT Profile	1470-1510
MBS1400	1400	1350-1390	150 Inline	1480-1540
			210 Inline	1540-1600
MBS1500	1500	1450-1490	150 Inline	1580-1640
			210 Inline	1640-1700
MBS1600	1600	1550-1590	150 Inline	1680-1740
			210 Inline	1740-1800
MBS1700	1700	1650-1690	150 Inline	1780-1840
			210 Inline	1840-1900

Pivot Door - with inline panel

Code	Door Size	Door Adjustment	Inline Panels / Profile	Final Adjustment
MBP700	700	650-690	-	650-690
			EXT Profile	670-710
MBP760	760	710-750	-	710-750
MBP800	800	750-790	-	750-790
			EXT Profile	770-810
MBP700	700	650-690	150 Inline	780-840
			210 Inline	840-900
MBP760	760	710-750	210 Inline	900-960
MBP1000	1000	950-990	EXT profile	970-1010
MBP900	900	850-890	150 Inline	980-1040
			210 Inline	1040-1100
MBP1000	1000	950-990	150 Inline	1080-1140
			210 Inline	1140-1200

Bifold Door - with inline panel

Code	Door Size	Door Adjustment	Inline Panels / Profile	Final Adjustment
MBB700	700	650-690	-	650-690
			EXT Profile	670-710
MBB760	760	710-750	-	710-750
MBB800	800	750-790	-	750-790
			EXT Profile	770-810
MBB700	700	650-690	150 Inline	780-840
			210 Inline	840-900
MBB760	760	710-750	210 Inline	900-960
MBB1000	1000	950-990	EXT profile	970-1010
MBB900	900	850-890	150 Inline	980-1040
			210 Inline	1040-1100
MBB1000	1000	950-990	150 Inline	1100-1140
			210 Inline	1140-1200



MERLYN'S FITTING TOOL!

Taking the hassle out of fitting!

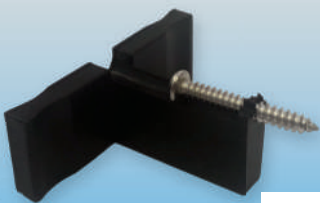

scan here for fitting information





MERLYN EASY

THE EASIEST DOOR TO FIT

The innovative EASY range takes the hassle out of fitting. The unique easy-fit mechanism makes fitting MERLYN EASY simple and easy to install.

ONE PERSON FIT

<p>Slot & lock system - no screws</p>	<p>No drilling on frame</p>
<p>Click on rollers</p>	<p>Assembled on tray</p>

Unique Fitting System

<p>Sliding, Corner & Quadrants</p>	<p>Pivot & Bifold</p>	<p>Side Panel</p>

EASY - Unique Features

Click on metal rollers



Rollers come completely pre-assembled and simple click onto the fixing.

Easy clean rollers



All rollers on merlyn EASY products are now quick release for easy cleaning.

No visible screws or fixings



There are no visible screws on the wall profile or side panel profiles, making this door easier to clean.

Installation tool



MERLYN EASY installation tool. Makes fitting even easier. *Not included with the Bifold or Pivot door.



Corner Door

Features

- » Height 1850mm
- » 6mm Toughened Safety Glass
- » Easy Clean Frame
- » Reversible
- » Chrome Handle
- » 5yr Guarantee
- » Manufactured in accordance with BS EN 14428

Corner Door

Corner Door				
Size	Code	Adjustment	Price € Exc. VAT	Price € Inc. VAT
800 x 800	KBC80	770 - 790	410.57	505.00
900 x 900	KBC90	870 - 890	425.20	523.00

Slot

Lock

Click on Rollers

scan here for fitting information

Technical drawing

Size	X	B
800 x 800	400	395
900 x 900	480	445

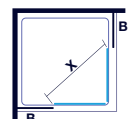

X: Door Opening
B: Fixed Panel



Sliding Door

Features

- » Height 1850mm
- » 6mm Toughened Safety Glass
- » Easy Clean Frame
- » Reversible
- » Chrome Handle
- » 5yr Guarantee
- » Manufactured in accordance with BS EN 14428

Sliding door with Side Panel / Shown Right Hand

Sliding Door					
Size	Code	Adjustment in Recess	Adjustment with Side Panel	Price € Exc. VAT	Price € Inc. VAT
1000	KBS10	950-990	960-1000	361.79	445.00
1100	KBS11	1050-1090	1060-1100	365.04	449.00
1200	KBS12	1150-1190	1160-1200	370.73	456.00

Optional Side Panel				
Size	Code	Adjustment in Recess	Price € Exc. VAT	Price € Inc. VAT
760	KBSP76	730 - 750	261.79	322.00
800	KBSP80	770 - 790	261.79	322.00
900	KBSP90	870 - 890	273.17	336.00

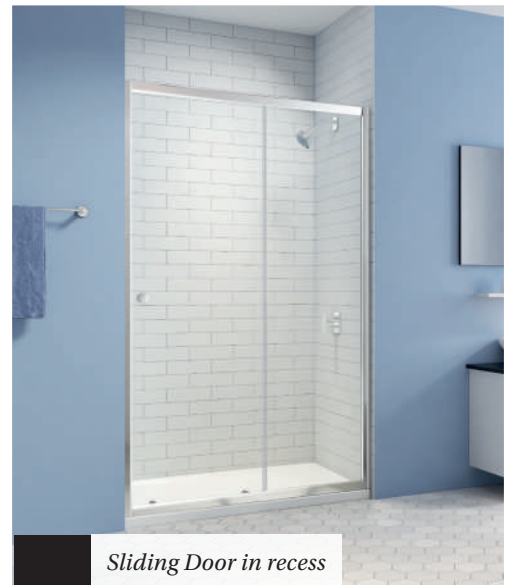

Sliding Door in recess

Slot

Lock

Click on Rollers

scan here for fitting information

Technical drawing

Size	X	B
1000	375	435
1100	425	485
1200	475	535

X: Door Opening
B = Fixed Panel
D = Side Panel

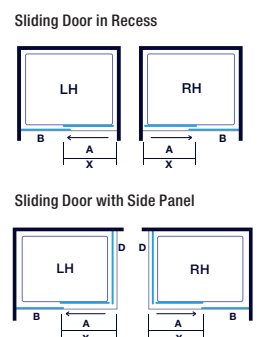



2 Door Quadrant

Features

- » Height 1850mm
- » 6mm Toughened Safety Glass
- » Easy Clean Frame
- » Reversible
- » Chrome Handle
- » 5yr Guarantee
- » Manufactured in accordance with BS EN 14428

2 Door Quadrant

2 Door Quadrant				
Size	Code	Adjustment	Price € Exc. VAT	Price € Inc. VAT
800 x 800	KB2Q80	770 - 790	378.05	465.00
900 x 900	KB2Q90	870 - 890	385.37	474.00
2 Door Offset Quadrant				
1000 x 800	KB2Q108	970 - 990 / 770 - 790	465.04	572.00
1200 x 800	KB2Q128	1170 - 1190 / 770 - 790	479.67	590.00
1200 x 900	KB2Q129	1170 - 1190 / 870 - 890	479.67	590.00



2 Door Offset Quadrant

Slot

Lock

Click on Rollers

scan here for fitting information

Technical drawing

Size	X	B	C
800 x 800	390	225	225
900 x 900	545	325	325
1000 x 800	470	425	225
1200 x 800	470	625	225
1200 x 900	545	625	325

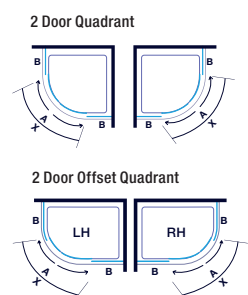

B: Straight Panel
C: Curved Panel
X: Door Opening

Pivot Door

Features

- » Height 1850mm
- » 6mm Toughened Safety Glass
- » Easy Clean Frame
- » Reversible
- » Chrome Handle
- » 5yr Guarantee
- » Manufactured in accordance with BS EN 14428



Pivot Door / Shown Right Hand

Pivot Door					
Size	Code	Adjustment in Recess	Adjustment with Side Panel	Price € Exc. VAT	Price € Inc. VAT
760	KBP76	710-750	715-735	372.36	458.00
800	KBP80	750-790	755-775	372.36	458.00
900	KBP90	850-890	855-875	372.36	458.00

Optional Side Panel				
Size	Code	Adjustment in Recess	Price € Exc. VAT	Price € Inc. VAT
760	KBSP76	730 - 750	261.79	322.00
800	KBSP80	770 - 790	261.79	322.00
900	KBSP90	870 - 890	273.17	336.00



Pivot Door in recess

Frame Locking System



scan here for fitting information



Technical drawing

Pivot Door in Recess

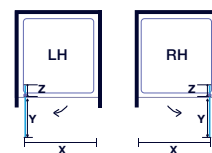

Pivot Door with Side Panel

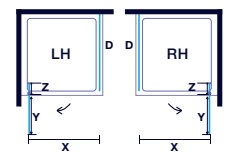

Size	X	Y
760	515	525
800	535	545
900	605	615

D: Side Panel
Y: Outside Door Swing
X: Door Opening
Z: Inside Door Swing



Bifold Door

Features

- » Height 1850mm
- » 6mm Toughened Safety Glass
- » Easy Clean Frame
- » Reversible
- » Chrome Handle
- » 5yr Guarantee
- » Manufactured in accordance with BS EN 14428



Bifold Door / Shown Right Hand

Bifold Door					
Size	Code	Adjustment in Recess	Adjustment with Side Panel	Price € Exc. VAT	Price € Inc. VAT
700	KBB70	660-690	655-675	378.05	465.00
760	KBB76	710-750	715-735	378.05	465.00
800	KBB80	750-790	755-775	378.05	465.00
900	KBB90	850-890	855-875	395.93	487.00

Optional Side Panel					
Size	Code	Adjustment in Recess	Price € Exc. VAT	Price € Inc. VAT	
760	KBSP76	730 - 750	261.79	322.00	
800	KBSP80	770 - 790	261.79	322.00	
900	KBSP90	870 - 890	273.17	336.00	



Bifold Door in recess

Frame Locking System

scan here for fitting information

Technical drawing

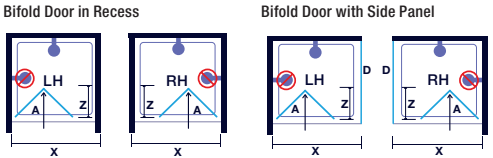

Size	X	Z
700	400	305
760	450	335
800	480	355
900	560	400

A: Moving Panel
 D: Side Panel
 X: Door Opening
 Z: Width of panel when folded

NEW

MERLYN™ | Spare Parts

**LOOKING FOR RELIABLE, AUTHENTIC
MERLYN SPARE PARTS FOR YOUR SHOWER?**

Our online store offers a wide range of stock,
ready for shipping.

www.merlynshowering.ie



SCAN FOR MORE
INFORMATION



Wetroom Panel / Shown in Brushed Bronze

8mm Wetroom Panels

Choose from a variety of shapes and sizes with our 8mm Wetroom Panels. Our modular system allows seamless customization for any wetroom space.

features

- » Height 2015mm (including rail)
- » Reversible
- » All panels from 700mm & above come with a 1000mm stabilising bar
- » 3m support post can be retro-fitted to glass thicknesses of 8mm
- » Suitable for recess or corner situation
- » Swivel panel can be retrofitted to any 8mm shower wall
- » Corner profile option available
- » Strong & sturdy construction

Wetroom Panels Chrome

Ref	Size	Adjustment	Code	Price € Exc. VAT	Price € Inc. VAT
A	300	275-290	8W30	258.54	340.00
B	400	375-390	8W40	267.48	352.00
C	500	475-490	8W50	276.42	364.00
D	600	575-590	8W60	291.06	382.00
E	700	675-690	8W70	312.20	411.00
F	760	735-750	8W76	315.45	415.00
G	800	775-790	8W80	318.70	419.00
H	900	875-890	8W90	322.76	425.00
I	1000	975-990	8W10	354.47	466.00
J	1100	1075-1090	8W11	381.30	501.00
K	1200	1175-1190	8W12	383.74	505.00
L	1400	1375-1390	8W14	442.28	582.00
M	1600	1575-1590	8W16	500.00	658.00

Please Note: Panels A-H are the only panels that can be used as an end panel. Panels A-D do not come with a stabilising bar / Panels E-M come with stabilising bar. All panels 700mm and above come with 1000mm straight bracing bar. Sizes 700mm-900mm come with T-shape bracket to join two bracing bars.

Additional Options Chrome

Ref	Size	Product	Code	Price € Exc. VAT	Price € Inc. VAT
N	200	Swivel panel	8WSV20	174.80	230.00
O	300	Swivel panel	8WSV30	183.74	242.00
P	400	Swivel panel	8WSV40	197.56	260.00
Q	3000	Vertical ceiling post	3MCP	143.90	189.00
R	2000	Corner post profile	8WCR	67.48	89.00
S	1000	Round bracing bar	N126CH	143.90	189.00
T	1500	Round bracing bar	N127CH	174.80	230.00
U	-	Round T- piece bracket	A04S0010	49.59	65.00
V	350	Angled stabilising bar	SP08SCU12320	103.25	144.00
W	400	Vertical ceiling bracing bar	CBB440	117.07	163.00

Note: 3m vertical ceiling post can be retro-fitted to glass thickness of 8mm. Corner profile post is suitable for L-shape corner situations only & recommend using a stabilising bar for all size panels with this configuration. Corner Profile must be used with two Wetroom Panels. Round bracing bar can be retrofitted to 8mm glass.

Technical drawing



How it works: To make up a Walk In wetroom to fit on a 1200mm x 800mm tray or area floor space. You pick panel A (700mm) and panel B (800mm), this also includes the recommended 500mm minimum opening for the Walk In.

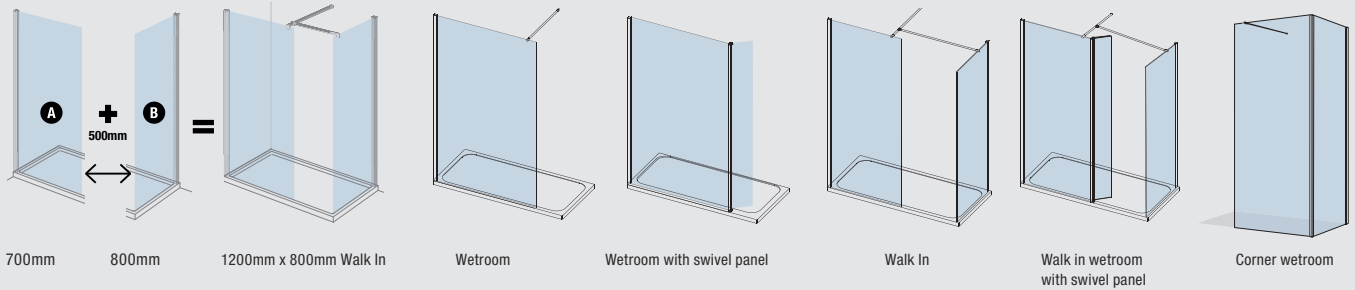

Wetroom Panels Colour

Ref	Size	Adjustment	Code	Colour Code	Price € Exc. VAT	Price € Inc. VAT
A	300	275-290	8W30	add MB / BBR or BBZ	386.99	476.00
B	400	375-390	8W40	add MB / BBR or BBZ	395.93	487.00
C	500	475-490	8W50	add MB / BBR or BBZ	405.69	499.00
D	600	575-590	8W60	add MB / BBR or BBZ	421.14	518.00
E	700	675-690	8W70	add MB / BBR or BBZ	443.90	546.00
F	760	735-750	8W76	add MB / BBR or BBZ	447.97	551.00
G	800	775-790	8W80	add MB / BBR or BBZ	451.22	555.00
H	900	875-890	8W90	add MB / BBR or BBZ	455.28	560.00
I	1000	975-990	8W10	add MB / BBR or BBZ	489.43	602.00
J	1100	1075-1090	8W11	add MB / BBR or BBZ	517.89	637.00
K	1200	1175-1190	8W12	add MB / BBR or BBZ	521.14	641.00
L	1400	1375-1390	8W14	add MB / BBR or BBZ	582.93	717.00
M	1600	1575-1590	8W16	add MB / BBR or BBZ	645.53	794.00

Please Note: Panels A-H are the only panels that can be used as an end panel. Panels A-D do not come with a stabilising bar / Panels E-M come with stabilising bar. All panels 700mm and above come with 1000mm straight bracing bar. Sizes 700mm -900mm come with T-shape bracket to join two bracing bars.

Additional Options Colour

Ref	Size	Product	Code	Colour Code	Price € Exc. VAT	Price € Inc. VAT
O	300	Swivel panel	8WSV30	add MB / BBR or BBZ	273.17	336.00
Q	3000	Vertical ceiling post	3MCP	add MB / BBR or BBZ	201.63	248.00
R	2000	Corner post profile	8WCR	add MB / BBR or BBZ	120.33	148.00
S	1000	Round bracing bar	N126	add MB / BBR or BBZ	201.63	248.00
T	1500	Round bracing bar	N127	add MB / BBR or BBZ	234.96	289.00
U	-	Round T- piece bracket	A04S0010	add B / BBR or BBZ	86.99	107.00
W	400	Vertical ceiling bracing bar	CBB440	add MB / BBR or BBZ	153.66	189.00

Note: 3m vertical ceiling post can be retro-fitted to glass thickness of 8mm. Corner profile post is suitable for L-shape corner situations only & recommend using a stabilising bar for all size panels with this configuration. Corner Profile must be used with two Wetroom Panels.

Tray Accessories

Size	Add-On	Code	Price € Exc. VAT	Price € Inc. VAT
-	White Waste Cap	DWASCAPWHT	15.45	19.00

Waste Cap for Touchstone trays comes in standard chrome. Please use code above for white waste cap.



Wetroom Panel / Shown in Brushed Brass



Wetroom Panel / Shown in Matt Black

Add Colour; Express yourself

When ordering your wetroom panel, please add the desired colour code to the end of the standard chrome code.

Example: 8W12 is the standard chrome code add **MB** for Matt Black, **BBR** for Brushed Brass or **BBZ** for Brushed Bronze.

E.G. 8W12MB = 8W12 Matt Black.

MB = Matt Black

BBR = Brushed Brass

BBZ = Brushed Bronze



MERLYN *bath screens*

some unique features

Innovative design and contemporary aesthetics bring this bathroom favourite to life. This modern collection has been created with the same superb materials and unrelenting attention to detail demonstrated across all Merlyn ranges.

6^{MM}
GLASS
THICKNESS

LIFETIME
GUARANTEE

Why choose MERLYN Bath Screens?

MERSHIELD
STAYCLEAR

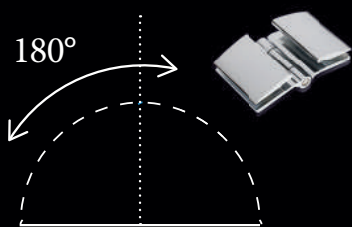

180° inwards swing

The signature piece of this range, the Two Panel Hinged Bath Screen features a secure 180° inwards swing which means you can position the glass where you can comfortably deflect water into the bath and not on to the floor!

Tested for quality & safety

All products are rigorously tested by us and by global health and safety experts to make sure they adhere to the highest quality standards.

Rise and fall

All Merlyn Bath Screens have a rise and fall hinge to make it easier for you to open.

HydraSEAL

Exclusive to MERLYN Bath Screens

HydraSEAL acts as an extra barrier, sealing the gap between the seal and the pivot point where water can usually escape.

It contains a high density foam that compresses onto the bath screen to form a tight seal and restricts water escaping from this problem area.

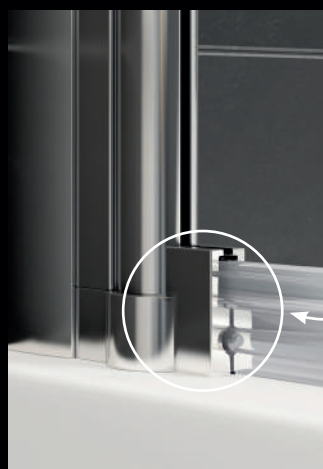

HydraSEAL creates a barrier to restrict leaking!

HydraSEAL is now available on our MB1, MB2, MB3, MB3A and MB3B bath screens.



Single Square Fixed Panel

Size	Code	Panel	Product Adjustment	Price € Exc. VAT	Price € Inc. VAT
800 x 1500	MB0	1	785-800	189.43	233.00

Features

- » Fixed frameless screen
- » 6mm toughened safety glass
- » Reversible
- » Lifetime guarantee

Single Curved

Size	Code	Panel	Product Adjustment	Price € Exc. VAT	Price € Inc. VAT
800 x 1500	MB1	1	780-800	208.94	257.00

Features

- » Frameless curved screen
- » 6mm toughened safety glass
- » Reversible
- » Lifetime guarantee
- » Door swing - 90 degrees in and out

Single Square

Size	Code	Panel	Product Adjustment	Price € Exc. VAT	Price € Inc. VAT
800 x 1500	MB2	1	780-800	226.02	278.00

Features

- » Frameless screen
- » 6mm toughened safety glass
- » Mershield Stayclear™
- » Reversible
- » Lifetime guarantee
- » Door swing - 90 degrees in and out

2 Panel Folding Curved

Size	Code	Panel	Product Adjustment	Price € Exc. VAT	Price € Inc. VAT
900 x 1500	MB3A	2	880 - 900	333.33	410.00

Features

- » Frameless screen
- » 6mm toughened safety glass
- » Reversible
- » Lifetime guarantee
- » Door swing - 90 degrees in and out

2 Panel Square

Size	Code	Panel	Product Adjustment	Price € Exc. VAT	Price € Inc. VAT
900 x 1500	MB3B	2	880 - 900	333.33	410.00

Features

- » Frameless screen
- » 6mm toughened safety glass
- » Reversible
- » Lifetime guarantee
- » Door swing - 90 degrees in and out



Touchstone Tray

Design details



Graduated adjustable leg and easy-fit tray panel kit.



Adjustable leg system.



90mm fast flow waste, includes hair trap and chrome cover.



*Quadrant tray is handed – please choose L for Left Hand and R for Right Hand when ordering.



TOUCHSTONE

Beautifully sculpted shower trays, angled and contoured to match enclosures and spaces, achieving the perfect combination of luxury, elegance and durability.

Features

- » 10 Year Guarantee
- » 50mm high to achieve minimalist design
- » Available as low level or with tray panel kits for easy installation
- » Compatible 90mm fast flow waste also available
- » More than 30 sizes available

Rectangular & Square Trays (Waste included)

Size	Code	Tray Panel Kit	Price € Exc. VAT	Price € Inc. VAT
700 x 700	S70SQ	Kit 4	140.65	173.00
760 x 760	S76SQ	Kit 4	142.28	175.00
800 x 800	S80SQ	Kit 4	144.72	178.00
900 x 900	S90SQ	Kit 4	172.36	212.00
800 x 700	S870RT	Kit 4	200.00	246.00
800 x 760	S876RT	Kit 4	205.69	253.00
900 x 700	S970RT	Kit 4	210.57	259.00
900 x 760	S976RT	Kit 4	212.20	261.00
900 x 800	S980RT	Kit 4	223.58	275.00
1000 x 700	S107RT	Kit 4	220.33	271.00
1000 x 760	S1076RT	Kit 4	223.58	275.00
1000 x 800	S108RT	Kit 4	225.20	277.00
1000 x 900	S109RT	Kit 4	225.20	277.00
1100 x 760	S1176RT	Kit 4	228.46	281.00
1100 x 800	S118RT	Kit 4	230.08	283.00
1100 x 900	S119RT	Kit 4	240.65	296.00
1200 x 700	S127RT	Kit 4	240.65	296.00
1200 x 760	S1276RT	Kit 4	245.53	302.00
1200 x 800	S128RT	Kit 4	250.41	308.00
1200 x 900	S129RT	Kit 4	250.41	308.00
1300 x 800	S138RT	Kit 3	335.77	413.00
1300 x 900	S139RT	Kit 3	340.65	419.00
1400 x 700	S147RT	Kit 3	340.65	419.00
1400 x 760	S1476RT	Kit 3	345.53	425.00
1400 x 800	S148RT	Kit 3	350.41	431.00
1400 x 900	S149RT	Kit 3	355.28	437.00
1500 x 700	S157RT	Kit 3	358.54	441.00
1500 x 760	S1576RT	Kit 3	360.16	443.00
1500 x 800	S158RT	Kit 3	365.04	449.00
1500 x 900	S159RT	Kit 3	368.29	453.00
1600 x 700	S167RT	Kit 3	370.73	456.00
1600 x 760	S1676RT	Kit 3	373.17	459.00
1600 x 800	S168RT	Kit 3	375.61	462.00
1600 x 900	S169RT	Kit 3	380.49	468.00
1685 x 700	S177RT	Kit 3	390.24	480.00
1680 x 760	S1776RT	Kit 3	395.12	486.00
1700 x 800*	S178RT	Kit 3	400.00	492.00
1700 x 900*	S179RT	Kit 3	410.57	505.00
1800 x 700*	S187RT	Kit 3	440.65	542.00
1800 x 800*	S188RT	Kit 3	450.41	554.00
1800 x 900*	S189RT	Kit 3	460.16	566.00

*Waste is Centred on 1700x800 - 1800x900 trays.

Quadrant Tray (Waste included)

Size	Code	Tray Panel Kit	Price € Exc. VAT	Price € Inc. VAT
800 x 800	S80Q	Kit 2	180.49	222.00
900 x 900	S90Q	Kit 2	185.37	228.00
1000 x 1000	S100Q	Kit 2	220.33	271.00

Offset Quadrant Tray (Waste included)

*900x760 LH	S976QL	Kit 1	220.33	271.00
*900x760 RH	S976QR	Kit 1	220.33	271.00
*1000 x 800 LH	S108QL	Kit 1	240.65	296.00
*1000 x 800 RH	S108QR	Kit 1	240.65	296.00
*1200 x 800 LH	S128QL	Kit 1	240.65	296.00
*1200 x 800 RH	S128QR	Kit 1	240.65	296.00
*1200 x 900 LH	S129QL	Kit 1	240.65	296.00
*1200 x 900 RH	S129QR	Kit 1	240.65	296.00

This product is handed – please choose L for Left Hand and R for Right Hand when ordering. White Waste Cap is for Touchstone trays only. Waste cap comes in chrome as standard.

Tray Accessories

Code	Price € Exc. VAT	Price € Inc. VAT
White Waste Cap	DWASCAPWHT 15.45	19.00
Complete Waste	DWAS 34.15	42.00



Touchstone-SR Tray

Design details



Graduated adjustable leg and easy-fit tray panel kit.



Adjustable leg system.



90mm fast flow waste, includes hair trap and chrome cover.



*Quadrant tray is handed – please choose L for Left Hand and R for Right Hand when ordering.



TOUCHSTONE-SR

We have carried out all the testing to give you and your family the peace of mind of showering in a safe environment and the splendour of this natural stone effect.

Features

- » 10 Year Guarantee
- » 50mm high to achieve minimalist design
- » Available as low level or with tray panel kits for easy installation
- » Slip-resistant is manufactured into the coating and won't wear
- » Compatible 90mm fast flow waste also available
- » More than 30 sizes available

Rectangular & Square Trays (Waste included)

Size	Code	Tray Panel Kit	Price € Exc. VAT	Price € Inc. VAT
800 x 800	S80SQAS	Kit 4	245.53	302.00
900 x 900	S90SQAS	Kit 4	250.41	308.00
900 x 800	S980RTAS	Kit 4	278.05	342.00
1000 x 800	S108RTAS	Kit 4	285.37	351.00
1000 x 900	S109RTAS	Kit 4	300.00	369.00
1100 x 800	S118RTAS	Kit 4	345.53	425.00
1200 x 700	S127RTAS	Kit 4	341.46	420.00
1200 x 760	S1276RTAS	Kit 4	344.72	424.00
1200 x 800	S128RTAS	Kit 4	345.53	425.00
1200 x 900	S129RTAS	Kit 4	355.28	437.00
1400 x 700	S147RTAS	Kit 3	440.65	542.00
1400 x 800	S148RTAS	Kit 3	450.41	554.00
1400 x 900	S149RTAS	Kit 3	460.16	566.00
1500 x 760	S1576RTAS	Kit 3	475.61	585.00
1500 x 800	S158RTAS	Kit 3	480.49	591.00
1500 x 900	S159RTAS	Kit 3	490.24	603.00
1600 x 700	S167RTAS	Kit 3	490.24	603.00
1600 x 800	S168RTAS	Kit 3	495.12	609.00
1600 x 900	S169RTAS	Kit 3	500.00	615.00
1685 x 700	S177RTAS	Kit 3	530.08	652.00
1700 x 800	S178RTAS	Kit 3	540.65	665.00
1700 x 900	S179RTAS	Kit 3	550.41	677.00

*Waste is centred on 1700x800 & 1700x900 trays.

Quadrant Tray (Waste included)

Size	Code	Tray Panel Kit	Price € Exc. VAT	Price € Inc. VAT
800 x 800	S80QAS	Kit 2	245.53	302.00
900 x 900	S90QAS	Kit 2	255.28	314.00
*1000 x 800 LH	S108QLAS	Kit 1	290.24	357.00
*1000 x 800 RH	S108QRAS	Kit 1	290.24	357.00
*1200 x 800 LH	S128QLAS	Kit 1	350.41	431.00
*1200 x 800 RH	S128QRAS	Kit 1	350.41	431.00
*1200 x 900 LH	S129QLAS	Kit 1	355.28	437.00
*1200 x 900 RH	S129QRAS	Kit 1	355.28	437.00

This product is handed – please choose L for Left Hand and R for Right Hand when ordering.

Tray Panel Kit

Tray Panel Kit	Code	Price € Exc. VAT	Price € Inc. VAT
Kit 1	DRK1	115.45	142.00
Kit 2	DRK2	115.45	142.00
Kit 3	DRK3	115.45	142.00
Kit 4	DRK4	115.45	142.00

Tray Accessories

	Code	Price € Exc. VAT	Price € Inc. VAT
White Waste Cap	DWASCAPWHT	15.45	19.00
Complete Waste	DWAS	34.15	42.00

Tray Waste Positions

Touchstone Trays

Shape	Size	Waste Position A, mm	Waste Position B, mm
Square		A	B
	760	148	148
	800	148	148
	900	148	148

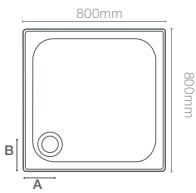

Rectangle	A	B
	800 x 700	148 148
	800 x 760	148 148
	900 x 700	148 148
	900 x 760	148 148
	900 x 800	148 148
	1000 x 700	148 148
	1000 x 760	148 148
	1000 x 800	148 148
	1000 x 900	148 148
	1100 x 760	148 148
	1100 x 800	148 148
	1100 x 900	148 148
	1200 x 700	148 148
	1200 x 760	148 148
	1200 x 800	148 148
	1200 x 900	148 148
	1300 x 800	148 148
	1300 x 900	148 148
	1400 x 700	148 148
	1400 x 760	148 148
	1400 x 800	148 148
	1400 x 900	148 148
	1500 x 700	148 148
	1500 x 760	148 148
	1500 x 800	148 148
	1500 x 900	148 148
	1600 x 700	148 148
	1600 x 760	148 148
	1600 x 800	148 148
	1600 x 900	148 148
	1685 x 700	148 148
	1680 x 760	148 148
	1600 x 900	148 148
	1685 x 700	148 148
	1700 x 800	130 850
	1700 x 900	130 850
	1800 x 760	130 900
	1800 x 800	130 900
	1800 x 900	130 900

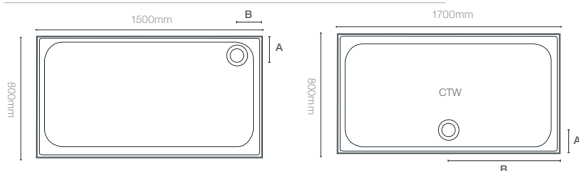

Waste is centred for 1700 x 800 / 1700 x 900 / 1800 x 700 / 1800 x 800 & 1800 x 900 trays

Touchstone Trays - Continued

Shape	Size	Waste Position A, mm	Waste Position B, mm
Quad		A	B
	800	250	130
	900	350	130

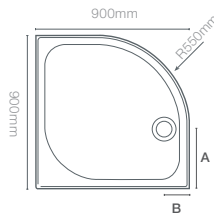

Offset Quad	A	B
	1000 x 800	350 130
	1200 x 800	450 130
	1200 x 900	450 130

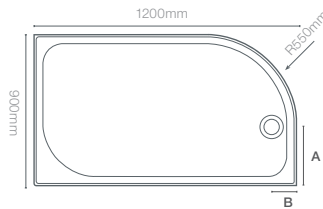

Left Handed (L) Right Handed (R)



Product is handed. Please choose L for Left or R for Right when ordering

Product Information

We have produced this product section to help you with your purchasing decision. For further information please contact your local stockist, details of which can be found at www.merlynshowering.com

Product information

All products are manufactured in accordance with EN14428 and utilise toughened safety glass to EN 12150.

All shower trays are manufactured in accordance with EN14527.

All doors feature adjustable wall profiles to compensate for out-of-true walls and have micro adjustment Features for fine tuning to obtain a perfect fit and operating action.

All enclosures, wetrooms and panels are Power Shower approved – will retain water under normal showering conditions.

Water retention is maintained in all products under normal showering conditions.

A selection of MERLYN enclosures are frameless in design. Spray/mist may escape therefore we would recommend use of these enclosures with tiled floors.

Opened cartons can not be returned. Returns carry a €40 box charge or €60 per unit where the sale is less than 30 days old. Returns over 30 days old will not be accepted.

All products are supplied complete with full installation instructions and the necessary fixings.

Check with your dealer for accurate matching of material samples. Product descriptions do not imply the use of precious or valuable materials.

Our policy of reviewing product design and development on a regular basis means MERLYN reserve the right to change product specifications and prices without notice.

Only 8mm wetroom panels and bath screens are covered by the Lifetime Guarantee. Please contact the MERLYN sales team for more details.

Glass shattering and parts subject to wear are not covered by the Lifetime Guarantee.

For full details on all product ranges please contact MERLYN Showering on 0808 1011429 or log onto www.merlynshowering.com.

Trays shown in this catalogue are for illustrative purposes only.

Images are for illustration purposes only.

The colours and finishes shown in the catalogue are as accurate as possible within the limits of the printing process. The positioning of all showering heads in the brochure is for illustrative purposes only.

All descriptions, specifications and particulars contained in this brochure are intended merely to represent a general idea of the products described herein and none of these form part of any contract to give rise to any independent or collateral liability upon the company.

Cleaning

- » It is important to clean your MERLYN shower door and tray after every use. Wipe down all the glass and metal parts with a soft cloth.
- » Do not allow lime scale to build up in hard water areas.
- » Ensure that any residual water on the glass is removed after every use.
- » Clean the glass regularly using soapy water.
- » Do not use abrasive products on any surfaces.
- » Install the enclosure in a well ventilated area.

Information and maintenance

Always read the instructions on the packaging, chrome is vulnerable to acid attack and some strong household cleaners including strong disinfectants, denture cleaners, hair dyes, wine making chemicals and photographic chemicals may contain acid. These materials may have a varying effect on the surface from black spots/streaks (which cannot be removed) to pitting the surface. Contact with these materials should be avoided.

Important shower tray information

It is up to the designer or installer to ensure that the tray and enclosure combination is arranged in such a way that water retention meets the customers needs.

- » The waste has the capacity to carry away 29L/Min. High powered systems may exceed this. Please check with the manufacturer.
- » Please ensure that the shower head is not positioned directly over the waste as this may restrict water flow rate.
- » Please ensure that the colour and size of shower tray are as per your order before installation.
- » You must inspect the product thoroughly before installation. Fitting the product is acceptance of quality.
- » The trays are handmade from natural material. Please allow for height variances due to manufacturing tolerances.
- » For open ended shower screens please consult your installer.
- » Shower trays must be fitted as per the fitting instruction. Deviation from the pre installation checks or fitting installation will void the guarantee.
- » When wet, the surface of the majority of shower trays will show an increase in the potential for slipping. This is particularly the case when soap, shampoo, bath oil etc. are used. It is important that designers, installers and users are aware of this.

Important

Although shower door and enclosure sizes are related to tray sizes it is important to note that most shower trays are tiled down to the rim, often over an 'up-stand'. The finished installation space may be less than the nominal tray size. MERLYN shower units are made to suit this remaining space.

Tray Finish min-max

The Tray Finish applies when fitting a door and a tray. These are the minimum and maximum dimensions that a shower door or enclosure will fit using standard wall profiles.

Tray finish

To find the correct Tray Finish dimension:

In a recess: Measure from the finished, tiled wall to the opposite finished, tiled wall.

In a corner: Measure from the finished, tiled wall to the edge of the tray.

Note: If the wall/walls are leaning in, this will further reduce your Tray Finish.

Adjustment

This is the min and max adjustment of the actual enclosure. These are the adjustment dimensions of the actual door excluding the tray. Therefore, these are the dimensions to follow when installing a enclosure in a wetroom application without a tray.

The guide below may be helpful in taking measurements to determine the shower door or enclosure size required. Dimensions given in this publication are in millimetres, are approximate and may vary with adjustment. They are subject to change without notice.

Please note that when a tray is fitted it is essential that the tray is level before any doors or enclosures are fitted.

Recess Location

Take the measurements after the tray is installed and the walls are tiled.

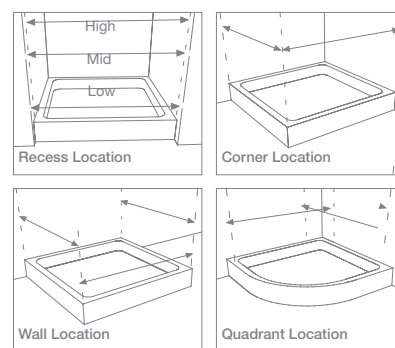

Bath Screens

- » MERLYN Bath Screens are not designed to fit on baths with stepped fronts, roll top rims or integral soap dishes.
- » Fitting of screen on baths which have raised head rests or shapes is not recommended.
- » There must be no items causing obstruction with the seal and bath, as any of the above may cause leaks.
- » When choosing your Bath Screen, please ensure that if your bath has bath handles, they do not interfere with the bath rim area where your screen will be placed.
- » When choosing an in-swing or folding Bath Screen, please ensure your swing area is not interfering with any brassware or internal shower Features. Similarly, when choosing an out-swing, please ensure the out-swing area is free from any obstructions.
- » It is recommended the shower head position is situated on the same wall to which the Bath Screen is fixed and in the centre of the shower area.

Loft Heights

Sliding Door Loft Heights

Loft Sliding Door (Height 1800mm)

Size	Adjustment	Code	Price € Ex. VAT	Price € Inc. VAT
1200	1150 - 1190	MBS1200/1800	743.09	914.00

Loft Side Panel (Height 1800mm)

Size	Adjustment	Code	Price € Ex. VAT	Price € Inc. VAT
800	770 - 790	MBSP800/1800	445.53	548.00
900	870 - 890	MBSP900/1800	478.05	588.00

2 Door Quadrants Loft Heights

Loft 2 Door Quadrant (Height 1800mm)

Size	Adjustment	Code	Price € Ex. VAT	Price € Inc. VAT
800 x 800	770 - 790	MB2Q800/1800	709.76	873.00
900 x 900	870 - 890	MB2Q900/1800	743.09	914.00

Bifold Door Loft Heights

Loft Bifold Door (Height 1800mm)

Size	Adjustment	Code	Price € Ex. VAT	Price € Inc. VAT
760	710 - 750	MBB760/1800	740.65	911.00
800	750 - 790	MBB800/1800	740.65	911.00
900	850 - 890	MBB900/1800	772.36	950.00

Loft Side Panel (Height 1800mm)

Size	Adjustment	Code	Price € Ex. VAT	Price € Inc. VAT
800	770 - 790	MBSP800/1800	445.53	548.00
900	870 - 890	MBSP900/1800	478.05	588.00

Measurements above are for both Bifold Door with a Side panel and in a Recess. Please Note: Cover strips do not come as standard and need to be ordered separately if required - see below.

MBOX Cover Strips

Side Panel Cover Strip Pack (1 Piece)

Code	Size	Price € Ex. VAT	Price € Inc. VAT
MBSPKIT	1900	70.73	87.00
MBSPKITMB	1900	79.73	98.06
MBSPKITBBR	1900	79.73	98.06

Please note: Cover strips do not come as standard and need to be ordered separately if required.

Standard Panel Cover Strip Pack (2 Pieces)

Code	Size	Price € Ex. VAT	Price € Inc. VAT
MBWPKIT	1900	90.24	110.99
MBWPKITMB	1900	99.13	121.92
MB8WPKITBBR	1900	99.13	121.92

Inline Panel Cover Strip Pack (1 Piece)

Code	Size	Price € Ex. VAT	Price € Inc. VAT
MBNKIT	1900	70.73	87.00

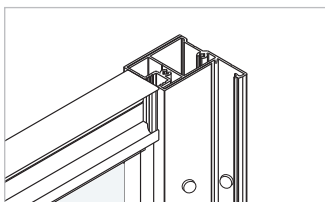

Without cover strip - chrome screw cover caps

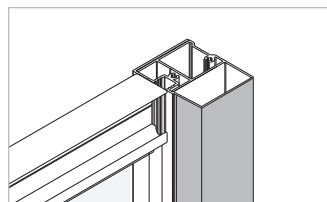

With cover strip - conceals all fixings

MBOX Extension Profiles

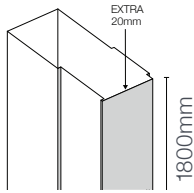

MBOX - Chrome only			
Order Code	Height	Price £ Exc. VAT	Price £ Inc. VAT
MBEXT1800	1800	63.33	76.00

MBOX extension profile: extra 20mm.

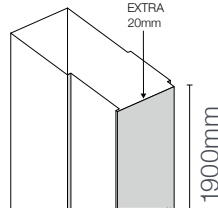

MBOX				
Order Code	Colour Code	Height	Price £ Exc. VAT	Price £ Inc. VAT
A0214B0	add MB or BBR	1900	65.83	79.00

MBOX extension profile: extra 20mm.

UKCA, CE & EN Information

The UKCA (UK Conformity Assessment) mark on MERLYN enclosures is the new standard marking for products on the market in Great Britain (England, Wales and Scotland). It is a declaration that the product complies with GB designated standards.

The CE markings on MERLYN enclosures is a declaration that the product complies with the essential requirements of the relevant European health, safety and environmental protection legislation.

EU and GB legislation requires manufacturers to display either the UKCA mark for Great Britain and a CE mark for the EU and Northern Ireland on their product or packaging. It is an offence to place a product on the relevant market without a UKCA for Great Britain or CE marking for the EU market.

The manufacturer is legally responsible for ensuring that the product conforms to the requirements of both directives.

The European Commission thus refers to the CE marking as a "Passport" which allows products to be freely circulated within the EU single market. The UKCA marking allows products to move freely within Great Britain.

Often consumers will consider the UKCA and CE markings on a product as an indication of conformance to laid down minimum standards and therefore, a minimum level of safety which other products may lack. Both markings are often seen by consumers as a "Symbol of Safety."

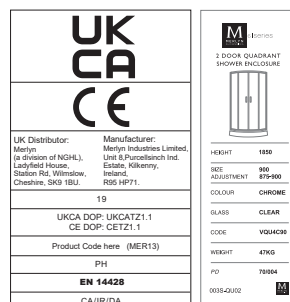

MERLYN invests heavily in its product development and as such guarantees that its glass fully complies with regulations and is manufactured in accordance with BS EN 14428. The rigorous testing of the glass ensures that the endurance, stability and water retention criteria meet high industry standards.

New GB, EU and NI label

ISO Certification

MERLYN has implemented an Integrated Management System comprising of Quality Management, Environmental Management and Occupational Health and Safety Management. An Integrated Management System ensures the seamless integration of several different standards into a common system that meets the requirements of each of these standards. These certifications are proof of MERLYN's credibility but also to instill confidence in our potential consumers that MERLYN will keep its promises.



Brochure Recycling

Please be aware our cover is non recyclable. Remove cover before recycling the internal pages.

MERLYN™

Unit 8, Purcellsinch Industrial Estate, Dublin Road,
Kilkenny, Ireland, R95 HP71.

T: 056 77 91555

Whatsapp: 08601 00 002

E irelandsales@merlyn.ie / irelandtechnical@merlyn.ie

www.merlynshowering.ie

